



Hawkeye Industries' Critical Flow Prover

The critical flow prover (CFP) device provides a means to determine gas flow rate, Q , using principles of adiabatic, frictionless compressible flow in the critical, or choked, condition.

Principles of Operation

A compressible fluid traveling at subsonic velocity through a duct of constant cross section will increase velocity when passing through a region of reduced cross-sectional area (in this case, an orifice) to satisfy mass flow continuity. To satisfy conservation of energy, the fluid pressure at the obstruction decreases (i.e. Venturi effect).

Maximum velocity at the obstruction is limited by the rate at which pressure waves can propagate through the fluid ("the speed of sound"), and the flow will not exceed this velocity at the obstruction. Known as choked, or critical flow, the orifice velocity remains constant over a wide range of downstream pressure and temperature conditions. Since volumetric flow is proportional velocity, the volume flow rate of a choked flow can be determined based solely on upstream absolute pressure and temperature.

Critical flow will occur as the ratio of the obstruction flow area to the duct flow area approaches zero, and the ratio of upstream to downstream pressure for air, assumed to be an ideal gas, is 0.528^1 . That is, the downstream pressure must be 0.528 times the upstream pressure (or less) in order to have critical flow at the obstruction. For example, to have critical flow with an upstream pressure of 10 MPa, the downstream pressure must be 5.28 MPa or less.

Empirically, natural gas exhibits critical flow behavior with straight-edge orifice diameters less than 60% of the pipe diameter, and ratio of absolute downstream to absolute upstream pressure between 0.56 and 0.58 . For example, a subsonic natural gas flow in a 50 mm pipe at 10 MPa will be critical through a 30 mm (or smaller) orifice, and downstream pressure of 5.6 MPa or less.

The critical flow prover device ensures choked flow over a wide range of downstream pressures, allowing the use of critical flow property relationships to determine flow rate. By using critical flow properties, variability as a result of fluctuating downstream conditions is negated,

allowing flow rates to be computed based solely on upstream conditions.

Device Description

The Hawkeye Industries Critical Flow Prover consists of a tubular section, approximately 6 pipe diameters long, with a smooth inside diameter and standard 2 NPT connection on the upstream end. The opposite end features a recess, with an o-ring face-seal, for a $1/4$ in. thick orifice plate, held in place by a knurled retention cap. Approximately one pipe diameter upstream of the orifice plate are a $1/2$ NPT and $1/4$ NPT pressure taps, suitable for gauge mounting and a thermowell.

Operating Information

The flow rate through the CFP is determined using the following equation:

$$Q = \frac{CP}{\sqrt{GT}} \quad (\text{eq. 1})$$

Where:

Q = Flow Rate (10^3 ft³ / 24 hr (aka Mcfh) or 10^3 m³ / d)

C = Orifice Coefficient (empirically derived, see tables 1a and 1b)

P = Absolute Upstream Pressure (psi or MPa)

G = Specific Gravity of Gas (air = 1.0)

T = Absolute Upstream Temperature (°R or K)

Note: Equation 1 assumes a perfect gas, and does not account for deviations from Boyle's Law behavior.

Units:

When determining flow rate in imperial units ([Mcfh], or [10^3 ft³/24hr]) use the following units in Equation 1:

C : From Table 1a.²

P : pounds per square inch [psi]

G : unitless

T : Rankine [°R]

¹ Eq. 9.32, White, F.M., (1999). *Fluid Mechanics*. New York: WCB McGraw Hill.

² Form 11-10, Page 3-2", Chandler Engineering Company (1959). Instructions: Critical Flow Prover – Bureau of Mines Type for Back Pressure Tests on Natural Gas Wells.

Likewise, to determine flow rate in metric, or SI units ($[10^3 \text{ m}^3/\text{d}]$) use the following units in equation 1:

C: From Table 1b.

P: Megapascals [MPa]

G: unitless

T: Kelvin [K]

Absolute Temperature:

Thermodynamic calculations require use of absolute temperature in computations. In imperial units, absolute temperature is measure in Rankine ($^{\circ}\text{R}$), calculated using the following formula:

$$[^{\circ}\text{R}] = [^{\circ}\text{F}] + 459.67 \quad (\text{eq. 2})$$

Example: $60^{\circ}\text{F} = 519.67^{\circ}\text{R}$

Similarly in SI, absolute temperature is measured in Kelvin (K) and is calculated using the following formula:

$$[K] = [^{\circ}\text{C}] + 273.15 \quad (\text{eq. 3})$$

Example: $17^{\circ}\text{C} = 290.15 K$

Table 1

Empirically Derived Orifice Coefficient				
* IMPERIAL AND METRIC (SI) UNITS *				
For 2 NPS [60.3 mm] Critical Flow Prover (2.00 in. [50.8 mm] bore)				
Orifice Diameter (in.)	(mm)	Coefficient, C (imperial)	Coefficient, C (metric)	Variance (%)
1/16	1.6	1.524	4.666	3.61
3/32	2.4	3.355	10.27	1.14
1/8	3.2	6.301	19.29	2.25
3/16	4.8	14.47	44.30	3.88
7/32	5.6	19.97	61.14	3.82
1/4	6.4	25.86	79.17	1.88
5/16	7.9	39.77	121.8	2.13
3/8	9.5	56.58	173.2	2.74
7/16	11.1	81.09	248.3	2.33
1/2	12.7	101.8	311.7	2.29
5/8	15.9	154	471.5	1.56
3/4	19.1	224.9	688.5	1.03
7/8	22.2	309.3	946.9	2.31
1	25.4	406.7	1245	2.09
1 1/8	28.6	520.8	1594	1.26
1 1/4	31.8	657.5	2013	3.61
1 3/8	34.9	807.8	2473	2.05
1 1/2	38.1	1002	3068	6.32

Tables 1 provides orifice coefficients for imperial units and metric (SI) units. The coefficients were derived from equation 1, using a known flow rate, Q, at a temperature of 60°F [519.67°R] and downstream pressure of 14.4 psia.

Graphical Representation:

The flow rate, in $10^3 \text{ ft}^3/24\text{hr}$ (Mcfh), has been calculated at atmospheric pressure and 60°F [519.67°R], and plotted on charts A1 through B4,

with a line for each orifice size (listed on the chart margins). Chart series A is scaled to provide legible values for orifice diameters 1/4 in. and under, while the series B charts show full-scale flow values.

Similarly, the flow rates, in $10^3 \text{ m}^3/\text{d}$ at 99.3 kPa and 16°C [289.15 K] have been calculated, and plotted on charts C1 through D4, with a line for each orifice size (listed on the chart margins). Chart series C is scaled to provide legible values for orifice diameters 1/4 in. and under, while the series D charts show full-scale flow values.

These charts are for informational purposes only. Use of equation 1 is required for accurate flow rates from a particular application.

Flow Charts

Scaled to 1/4 in. Orifice Plate Full Flow (Imperial Units):

Table A1:

Flow Rate vs. Upstream Pressure (100 psig),

Table A2:

Flow Rate vs. Upstream Pressure (500 psig),

Table A3:

Flow Rate vs. Upstream Pressure (1000 psig)

Table A4:

Flow Rate vs. Upstream Pressure (3000 psig)

Full Scale Flow (Imperial Units):

Table B1:

Flow Rate vs. Upstream Pressure (100 psig)

Table B2:

Flow Rate vs. Upstream Pressure (500 psig)

Table B3:

Flow Rate vs. Upstream Pressure (1000 psig)

Table B4:

Flow Rate vs. Upstream Pressure (3000 psig)

Scaled to 1/4 in. Orifice Plate Full Flow (Metric Units):

Table C1:

Flow Rate vs. Upstream Pressure (1 MPa g)

Table C2:

Flow Rate vs. Upstream Pressure (5 MPa g)

Table C3:

Flow Rate vs. Upstream Pressure (10 MPa g)

Table C4:

Flow Rate vs. Upstream Pressure (20 MPa g)

Full Scale Flow (Metric Units):

Table D1:

Flow Rate vs. Upstream Pressure (1 MPa g)

Table D2:

Flow Rate vs. Upstream Pressure (5 MPa g)

Table D3:

Flow Rate vs. Upstream Pressure (10 MPa g)

Table D4:

Flow Rate vs. Upstream Pressure (20 MPa g)

Schematic

Critical Flow Prover, DWG# CFP-200-GD

Chart A1: Flow Rate vs. Upstream Pressure (Imperial Units)
100 psi Upstream Pressure, All Critical Orifices

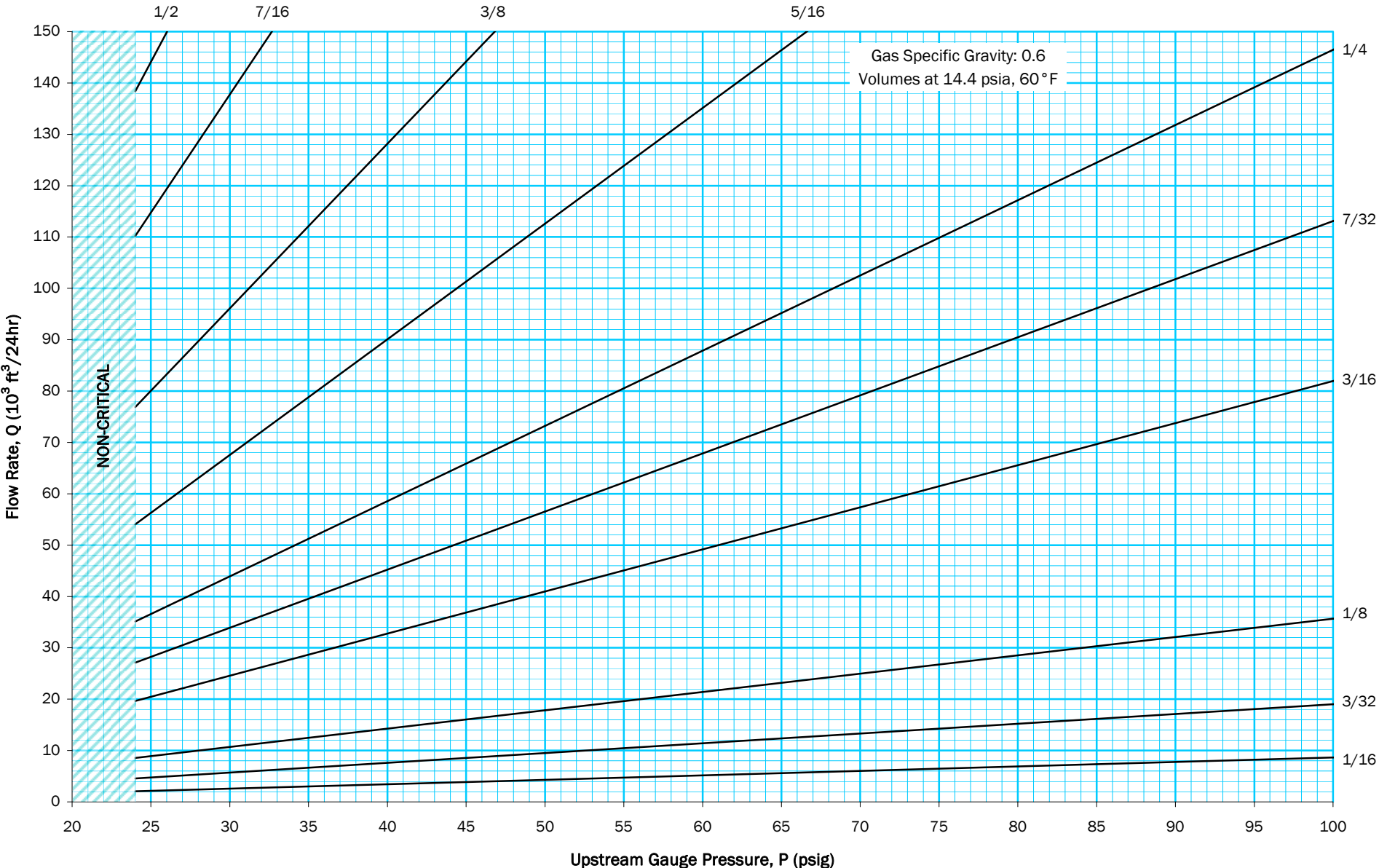

Informational purposes only. Calculate flow rates using equation 1.

Revised August 2010

Chart A2: Flow Rate vs. Upstream Pressure (Imperial Units)

500 psi Upstream Pressure, All Critical Orifices

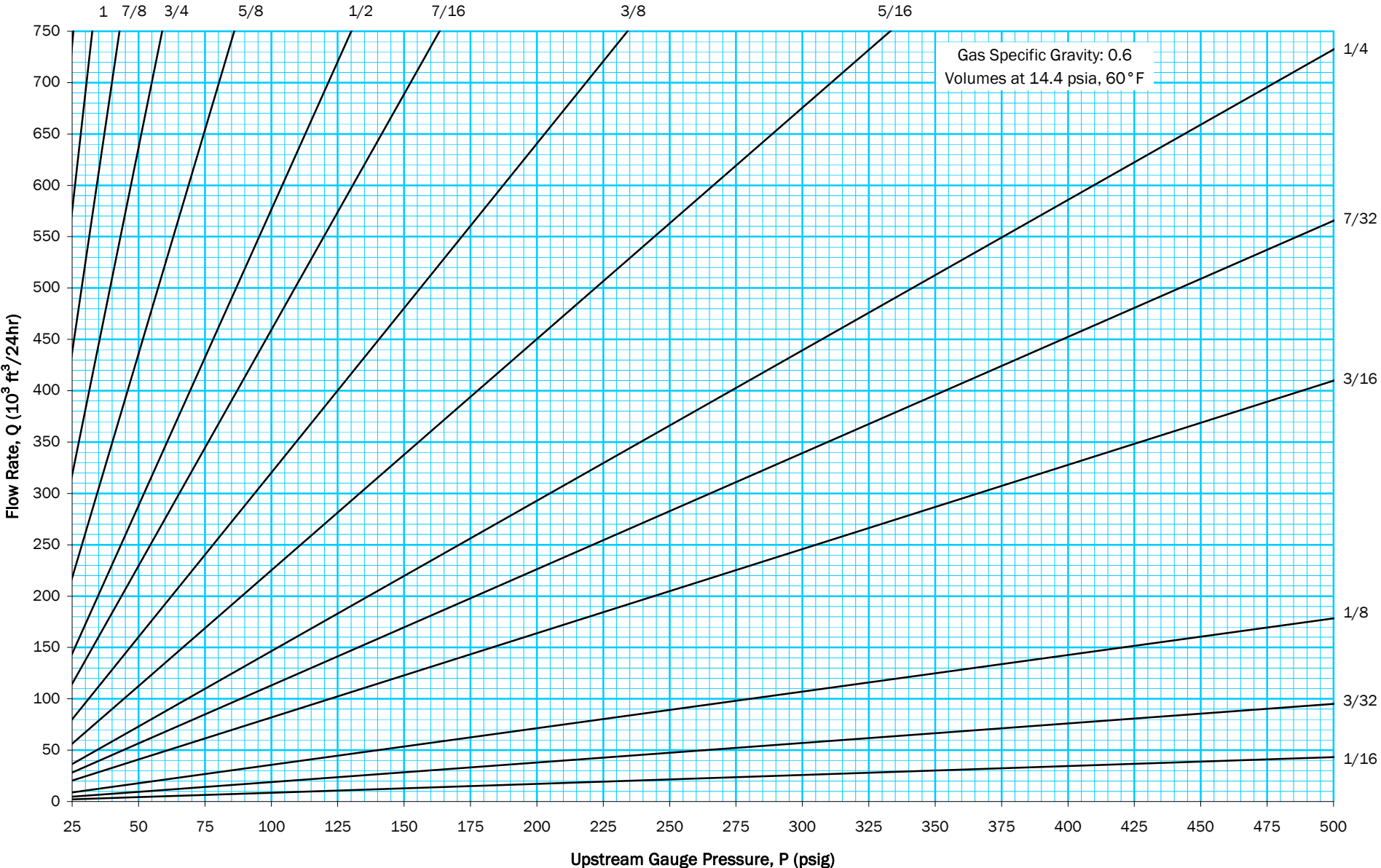

Informational purposes only. Calculate flow rates using equation 1.

Revised August 2010

Chart A3: Flow Rate vs. Upstream Pressure (Imperial Units)

1000 psi Upstream Pressure, All Critical Orifices

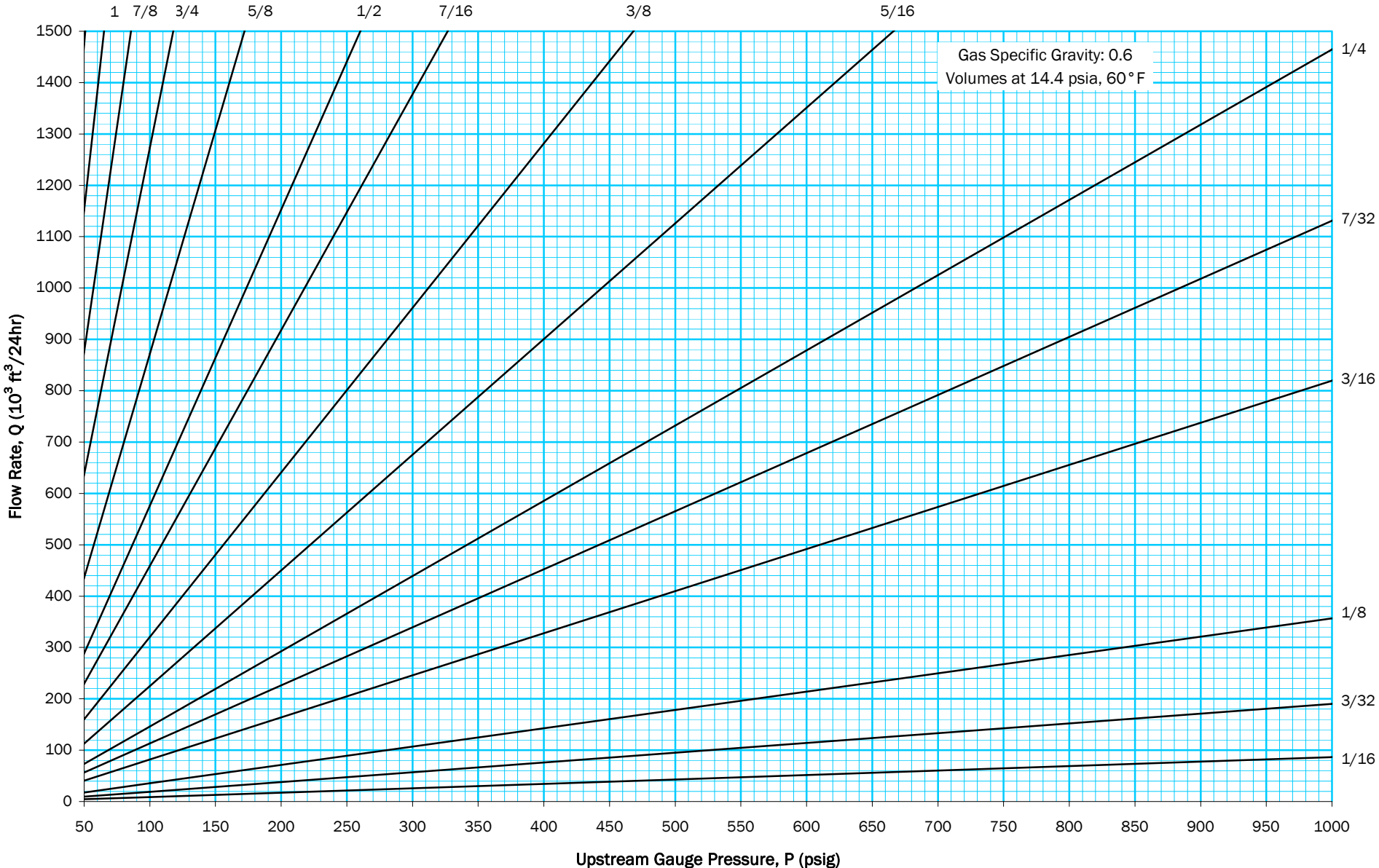

Informational purposes only. Calculate flow rates using equation 1.

Revised August 2010

Chart A4: Flow Rate vs. Upstream Pressure (Imperial Units)
3000 psi Upstream Pressure, All Critical Orifices

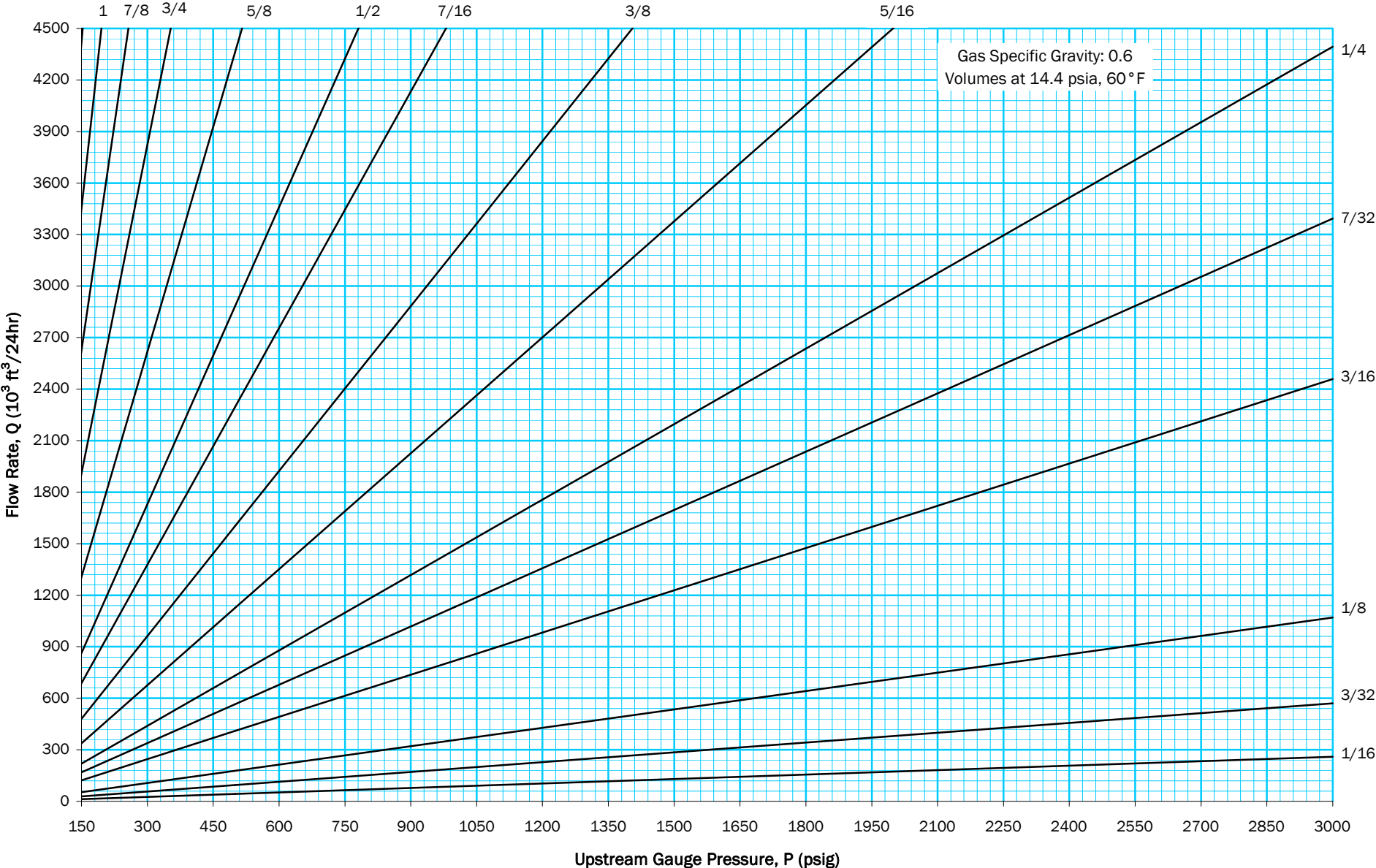

Informational purposes only. Calculate flow rates using equation 1.

Revised August 2010

Chart B1: Flow Rate vs. Upstream Pressure (Imperial Units)
100 psi Upstream Pressure, Orifices 5/16 and Larger

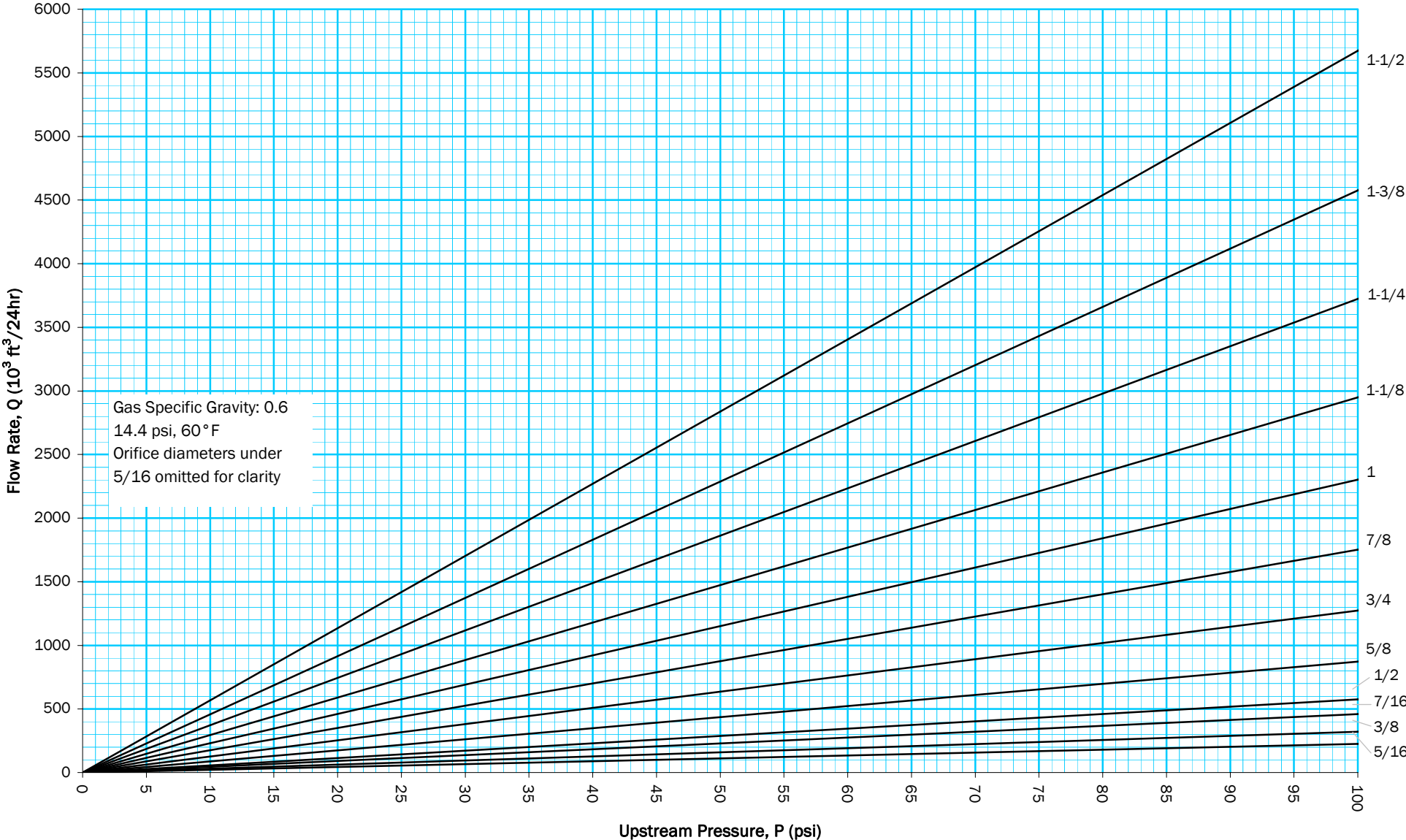
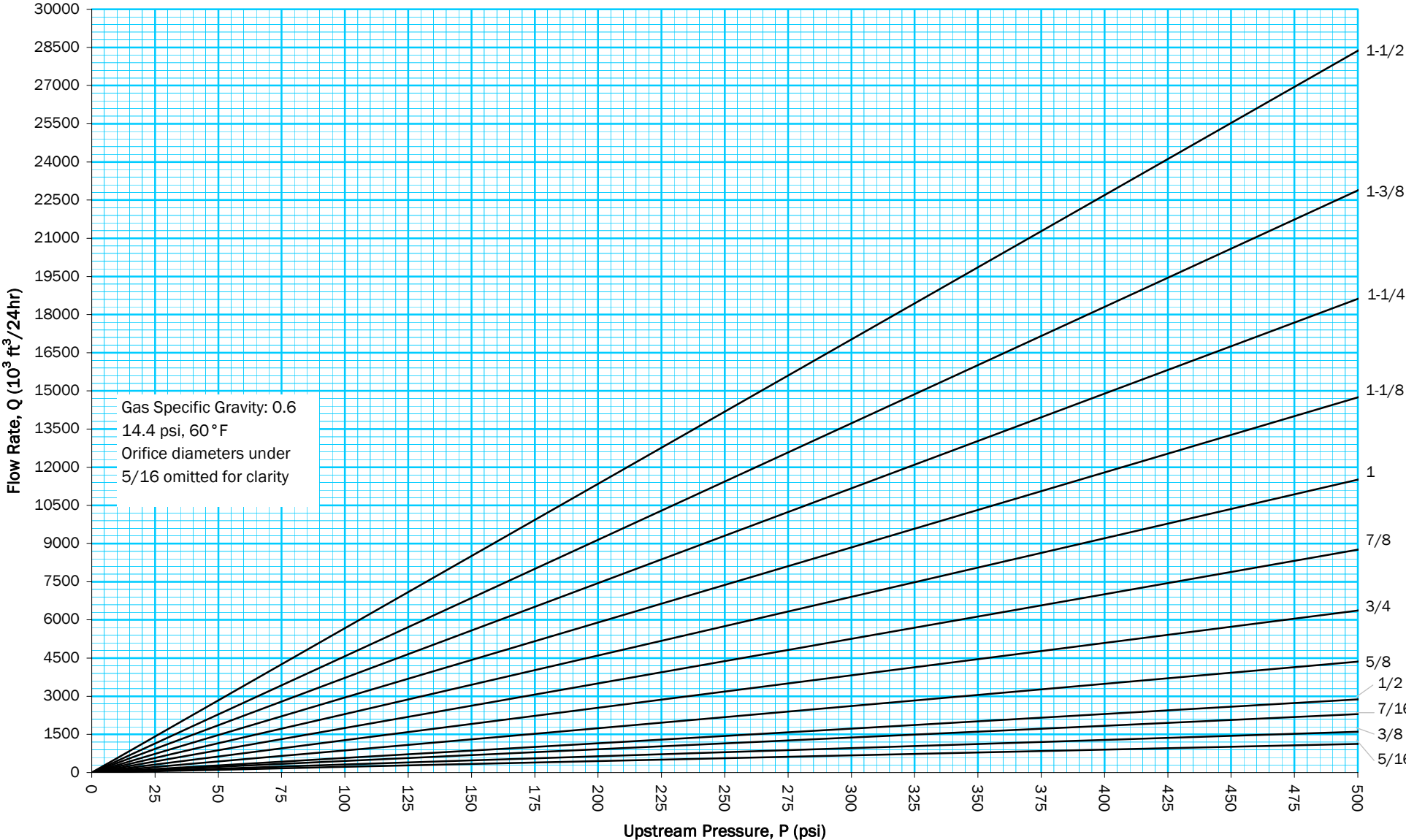

Chart B2: Flow Rate vs. Upstream Pressure (Imperial Units)
500 psi Upstream Pressure, Orifices 5/16 and Larger



Informational purposes only. Calculate flow rates using equation 1.

Revised August 2010

Chart B3: Flow Rate vs. Upstream Pressure (Imperial Units)
1000 psi Upstream Pressure, Orifices 5/16 and Larger

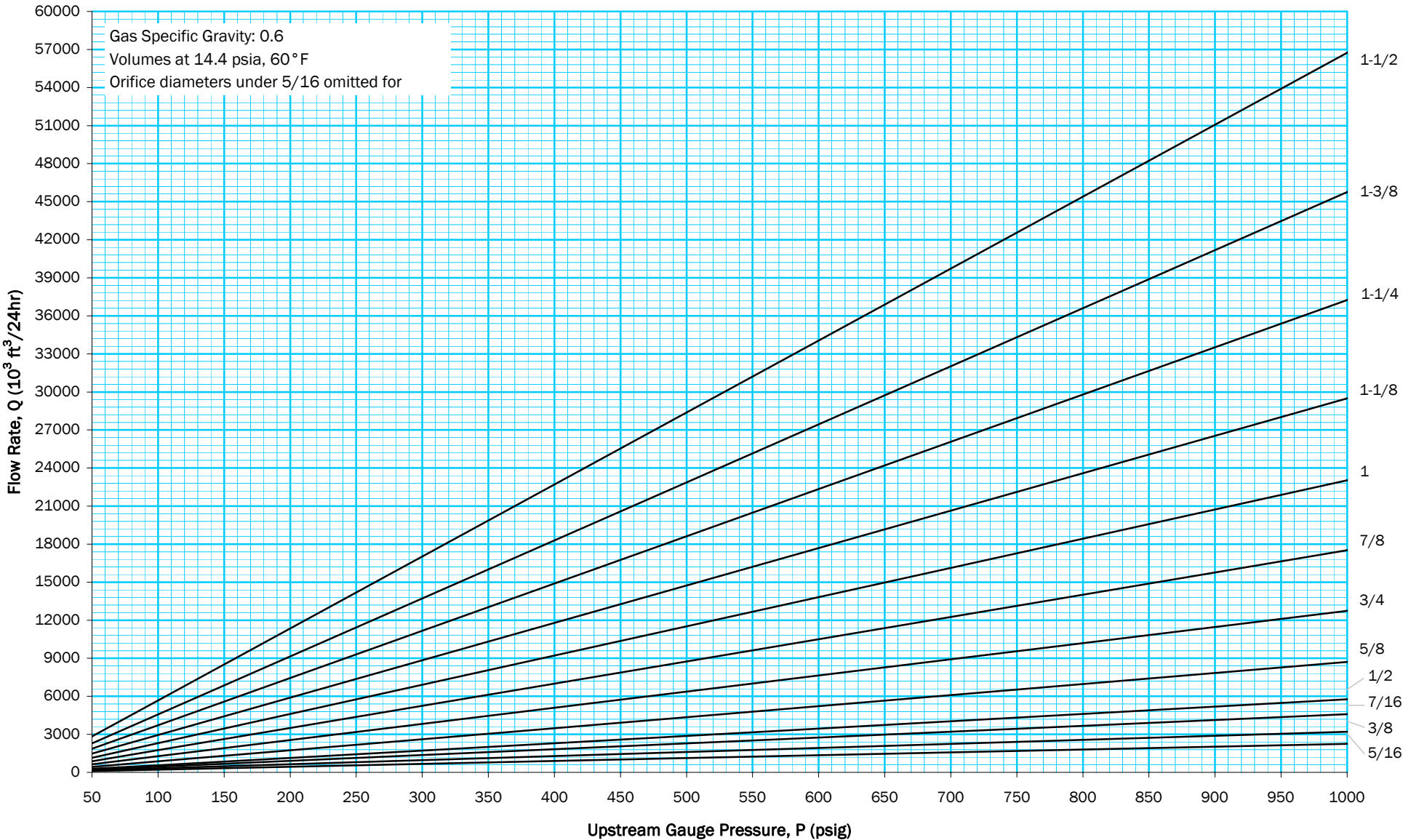

Informational purposes only. Calculate flow rates using equation 1.

Revised August 2010

Chart B4: Flow Rate vs. Upstream Pressure (Imperial Units)
3000 psi Upstream Pressure, Orifices 5/16 and Larger

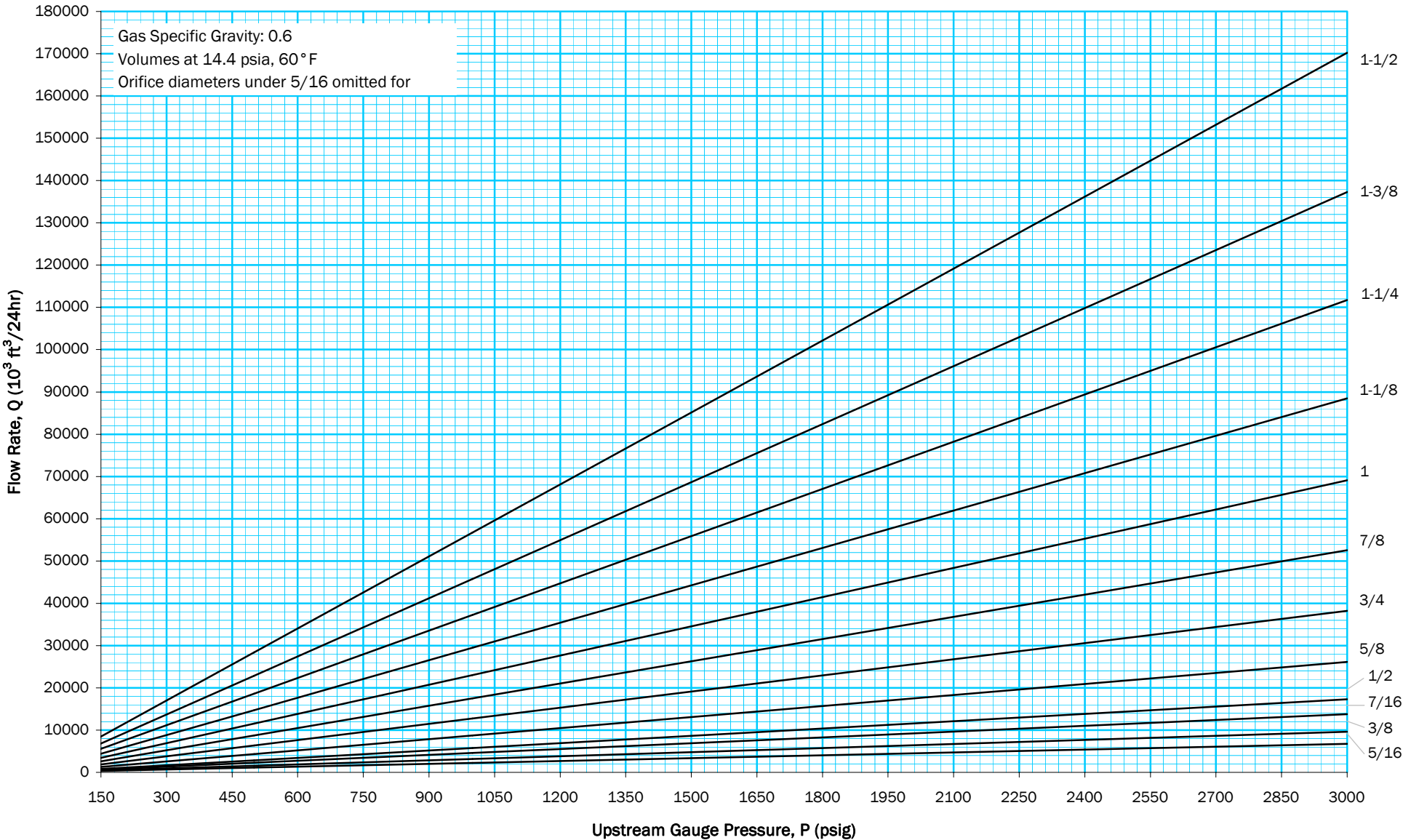

Informational purposes only. Calculate flow rates using equation 1.

Revised August 2010

Chart C1: Flow Rate vs. Upstream Pressure (Metric Units)
1 MPa Upstream Pressure, All Critical Orifices

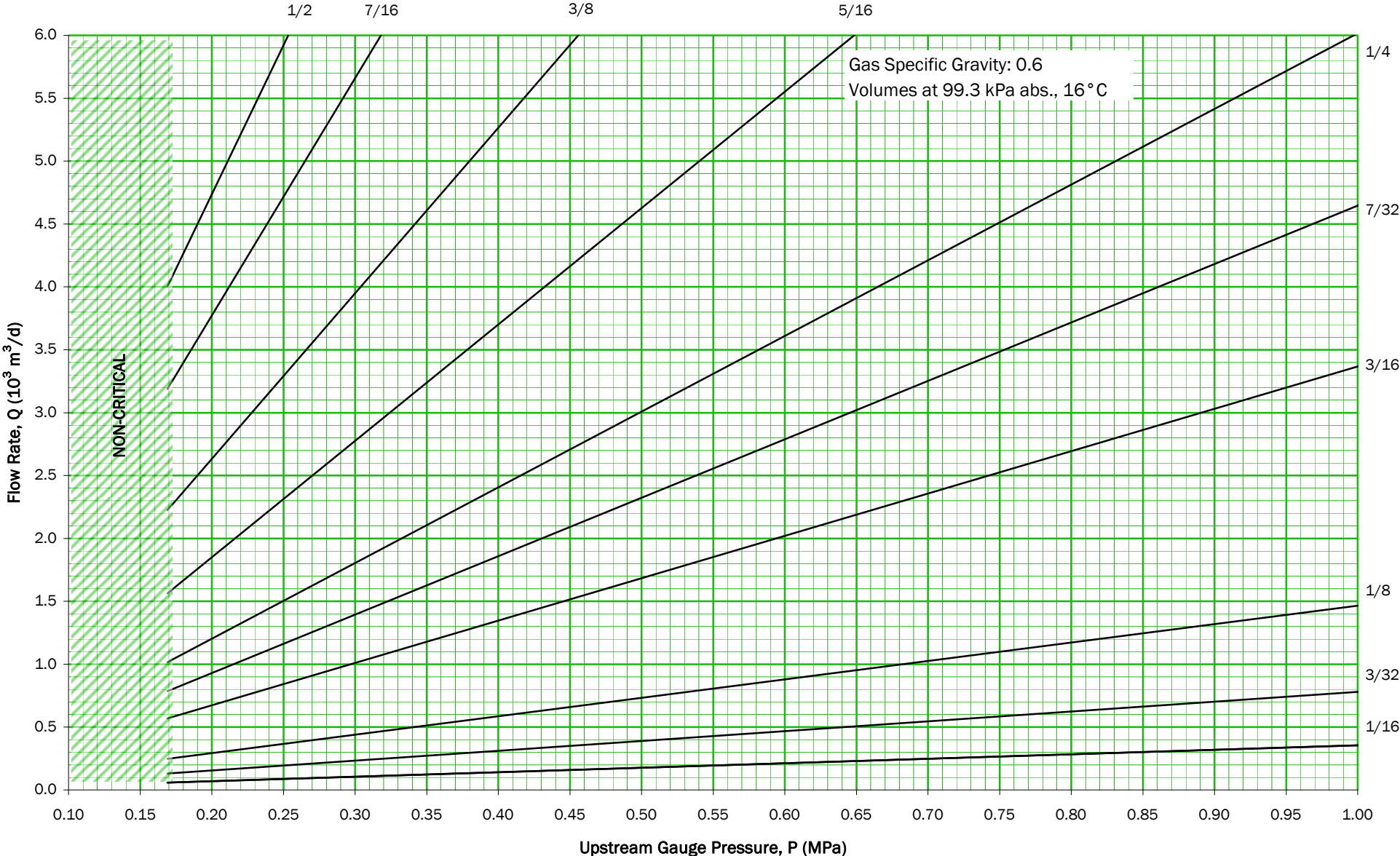

Informational purposes only. Calculate flow rates using equation 1.

Revised August 2010

Chart C2: Flow Rate vs. Upstream Pressure (Metric Units)
5 MPa Upstream Pressure, All Critical Orifices

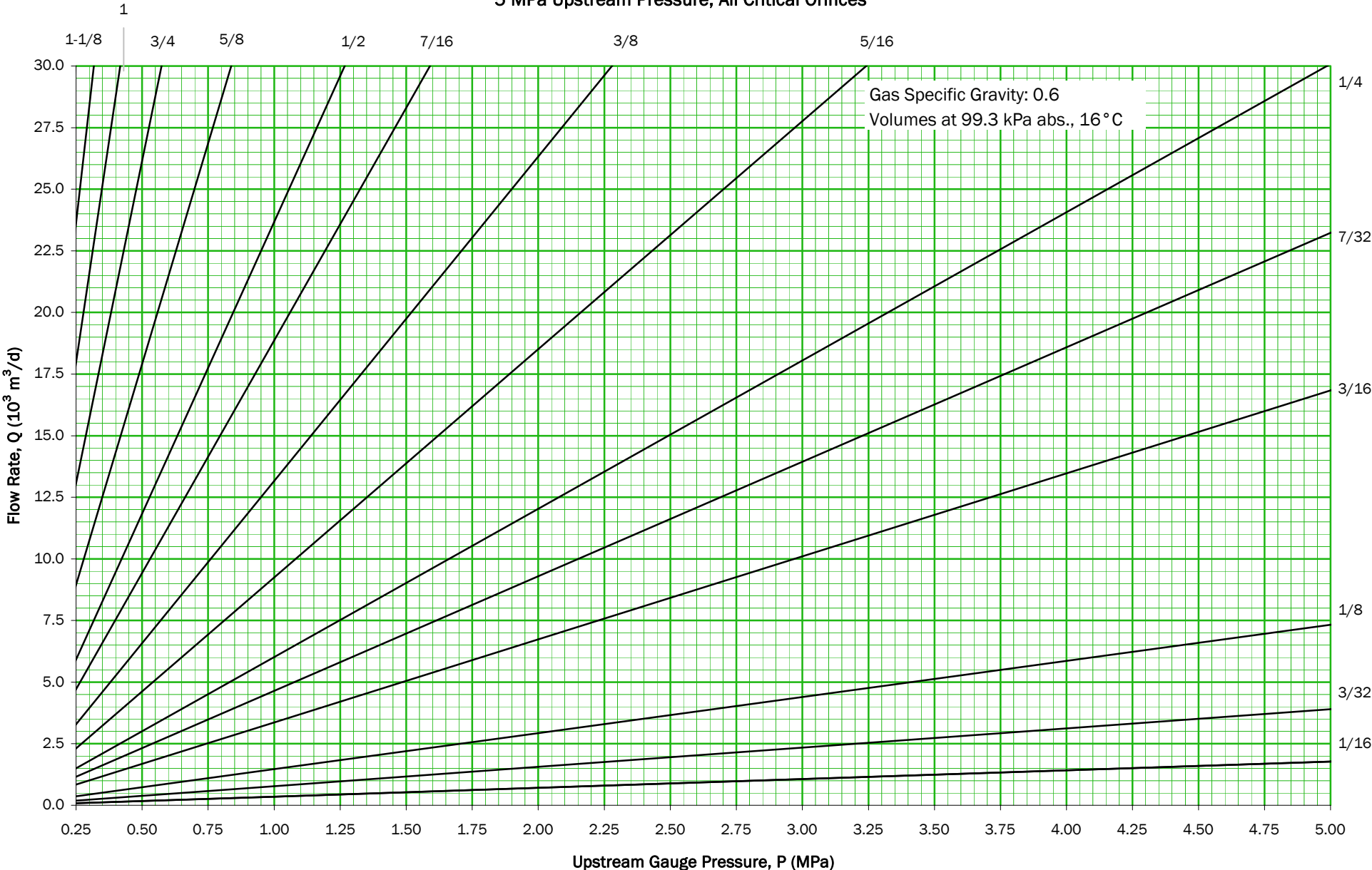

Informational purposes only. Calculate flow rates using equation 1.

Revised August 2010

Chart C3: Flow Rate vs. Upstream Pressure (Metric Units)
10 MPa Upstream Pressure, All Critical Orifices

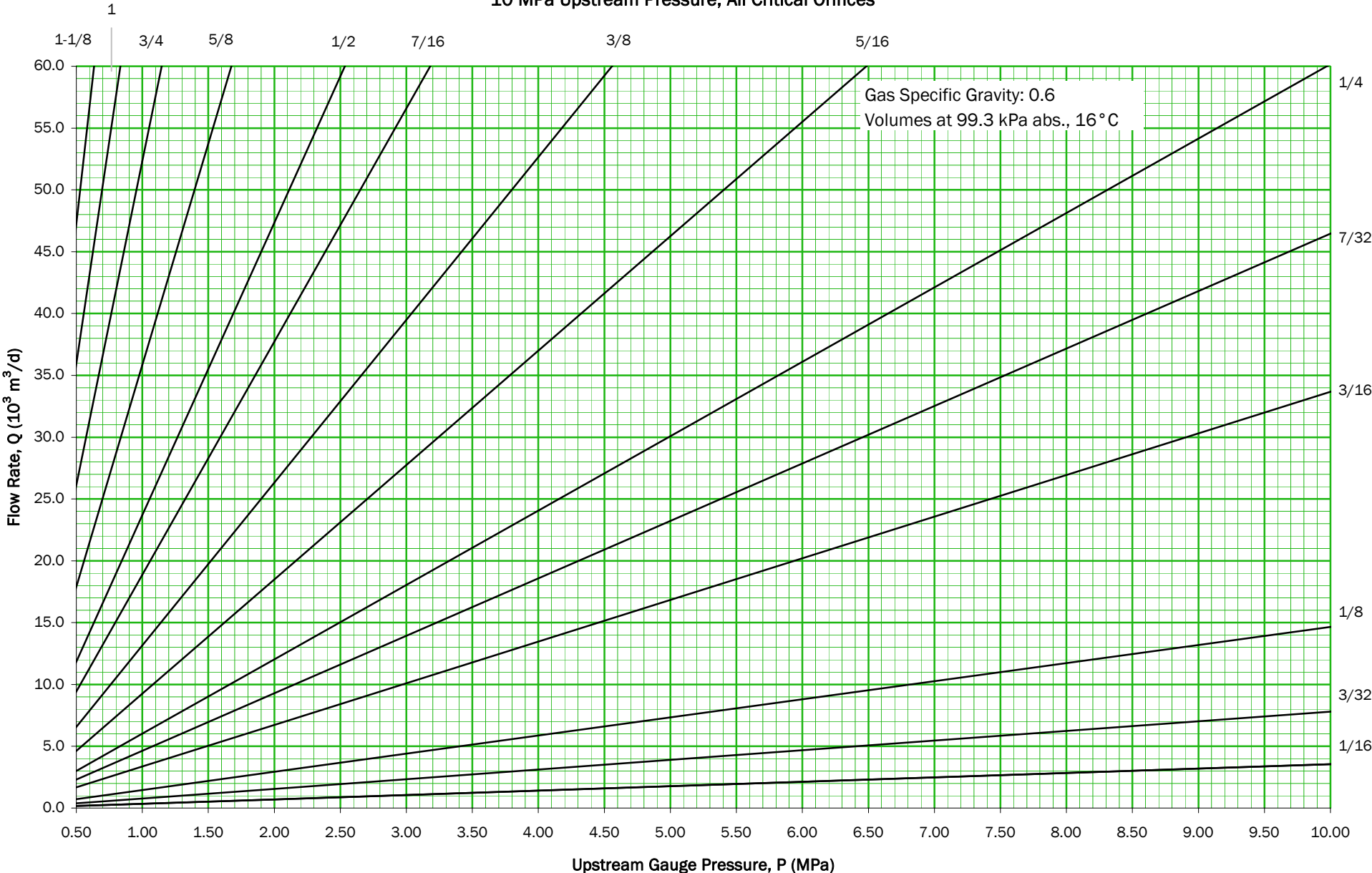

Informational purposes only. Calculate flow rates using equation 1.

Revised August 2010

Chart C4: Flow Rate vs. Upstream Pressure (Metric Units)
20 MPa Upstream Pressure, All Critical Orifices

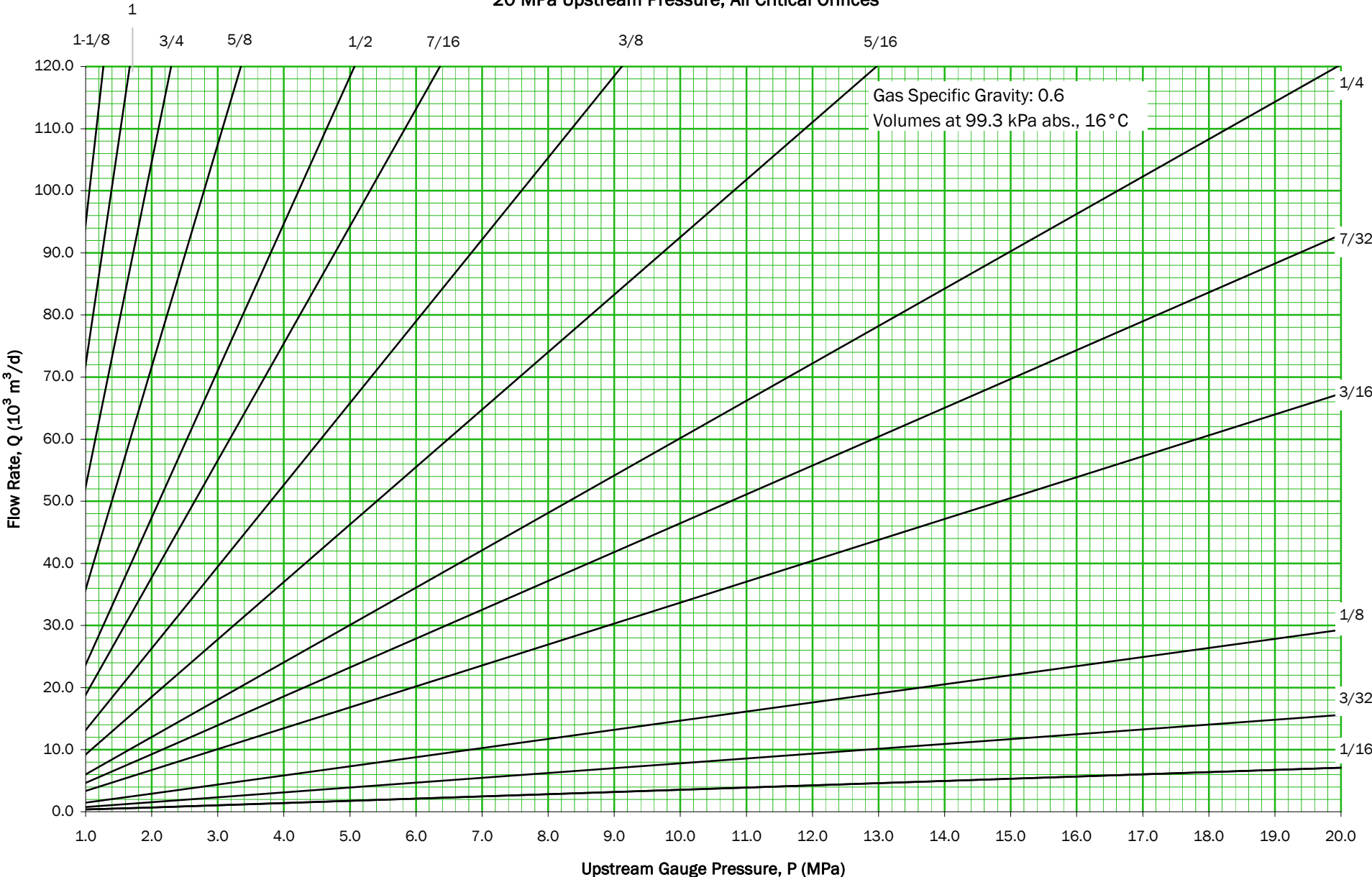

Informational purposes only. Calculate flow rates using equation 1.

Revised August 2010

Chart D1: Flow Rate vs. Upstream Pressure (Metric Units)
1 MPa Upstream Pressure, Orifices 5/16 and over

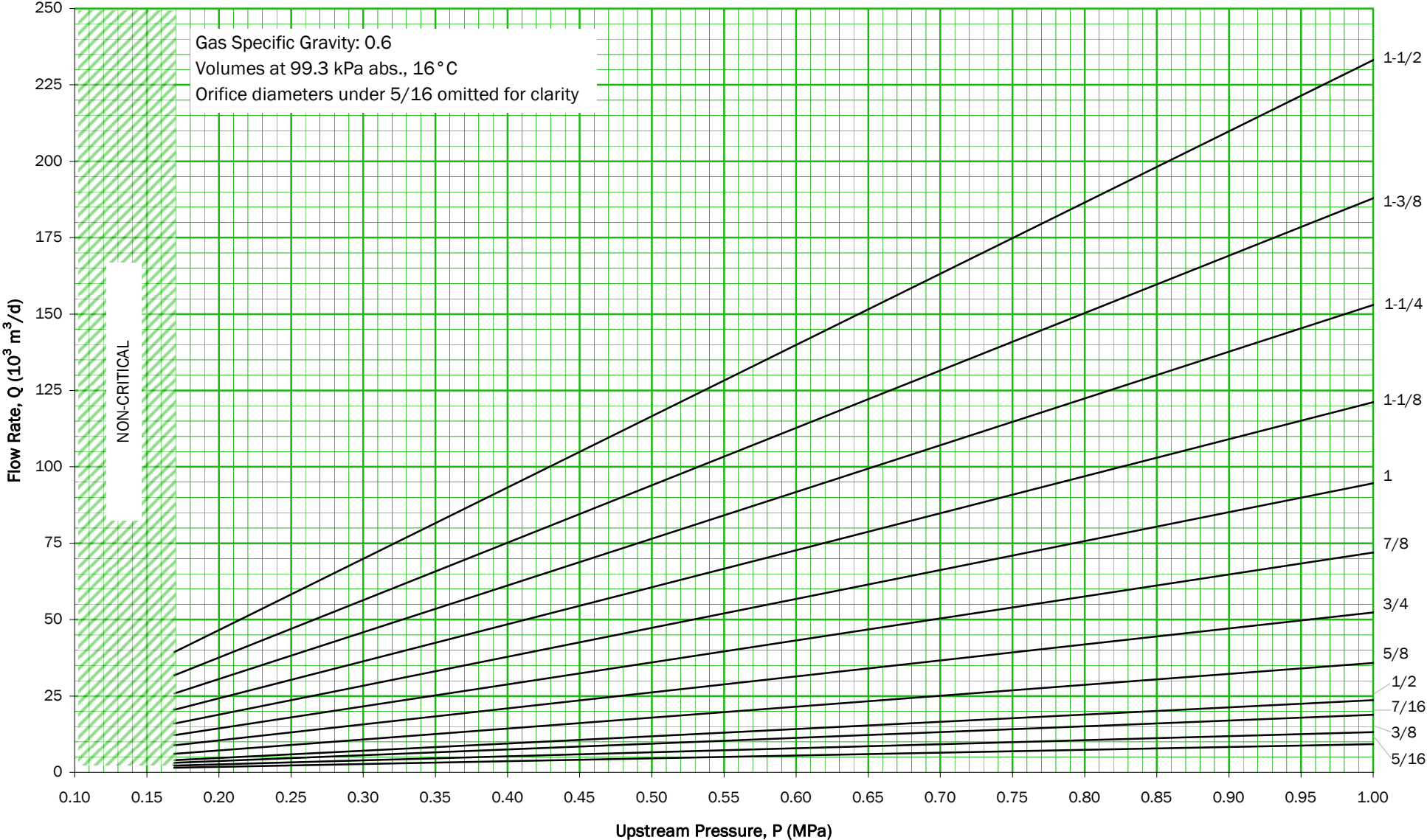

Informational purposes only. Calculate flow rates using equation 1.

Revised August 2010

Chart D2: Flow Rate vs. Upstream Pressure (Metric Units)
5 MPa Upstream Pressure, Orifices 5/16 and over

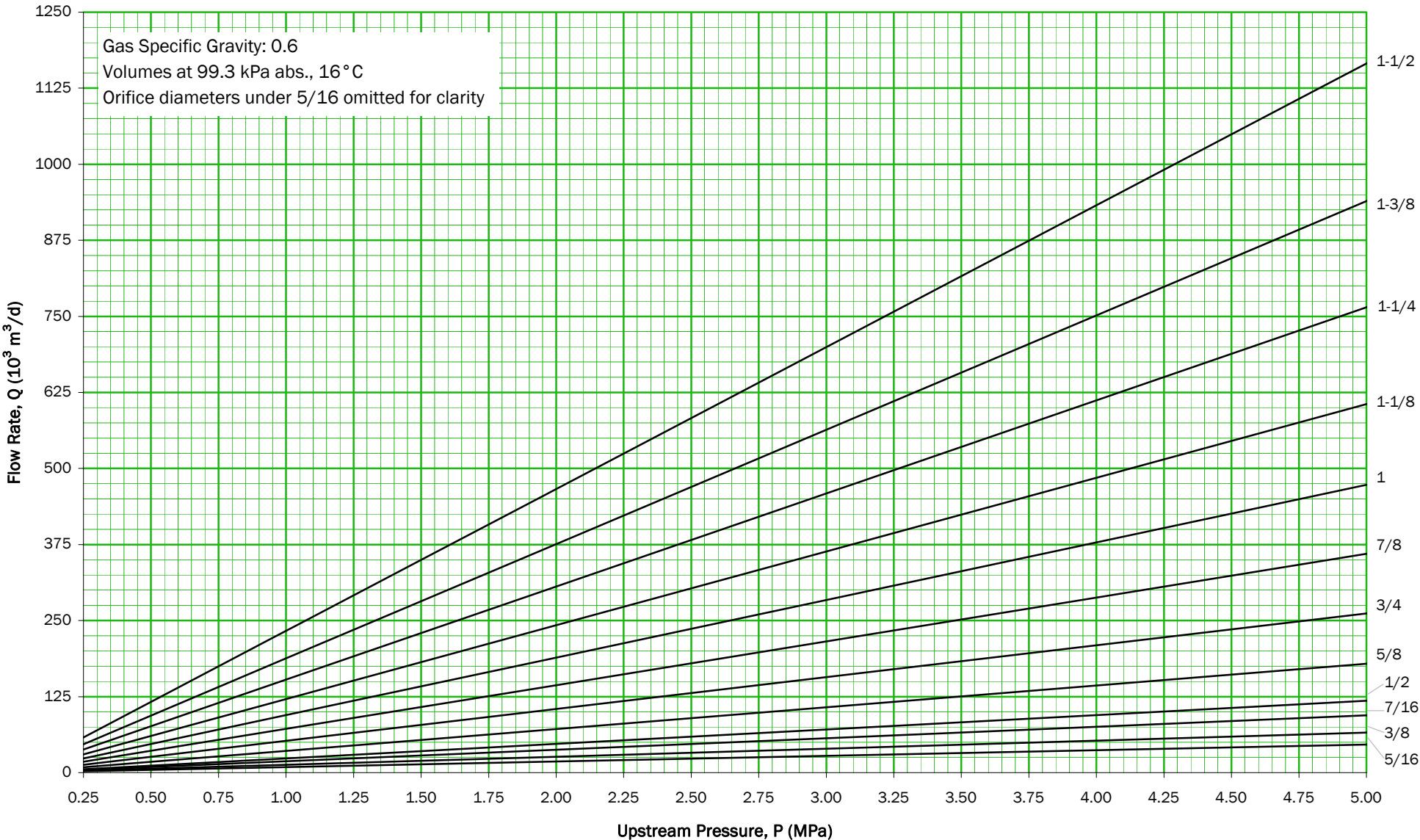

Informational purposes only. Calculate flow rates using equation 1.

Revised August 2010

Chart D3: Flow Rate vs. Upstream Pressure (Metric Units)
 10 MPa Upstream Pressure, Orifices 5/16 and over

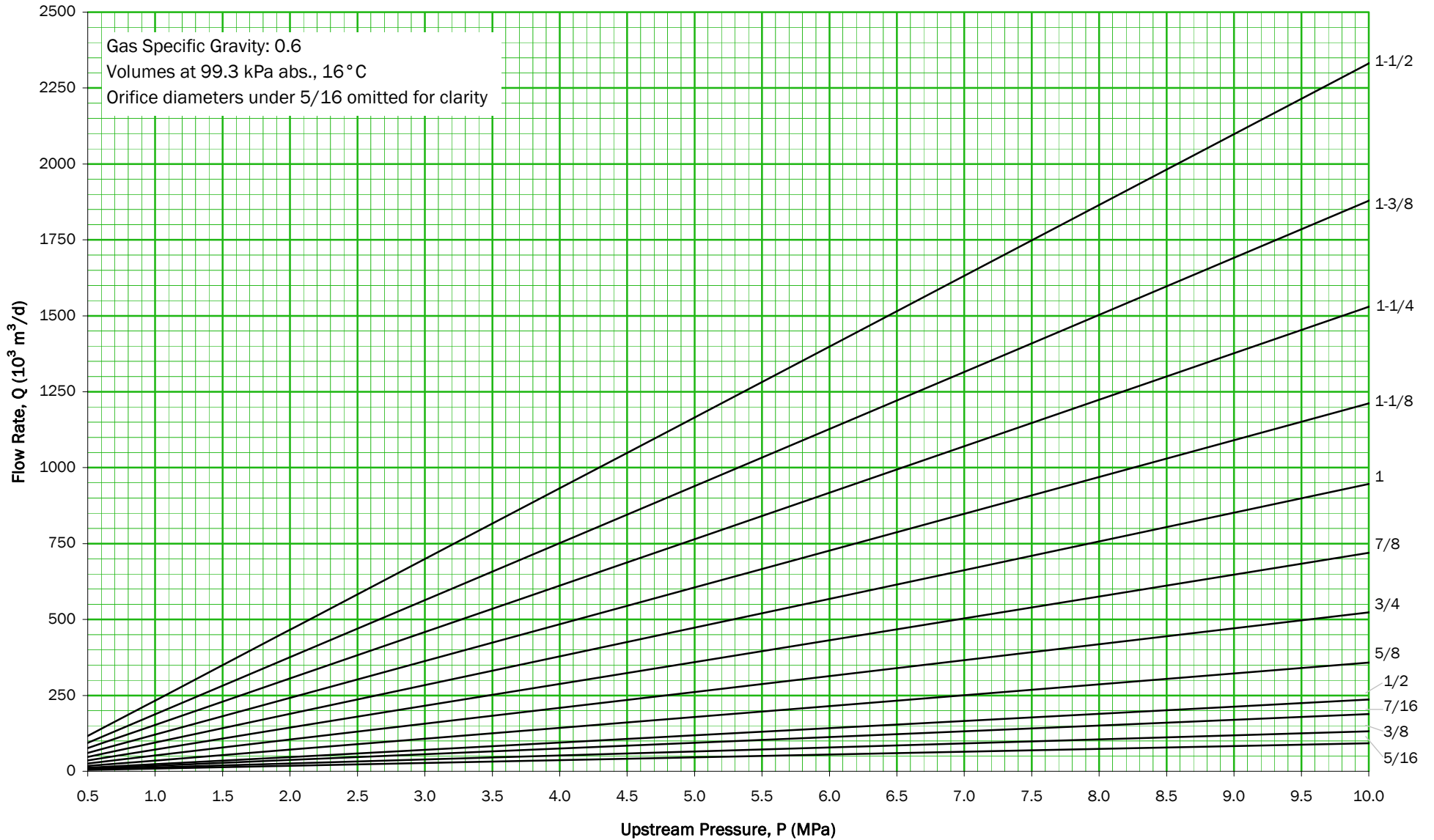
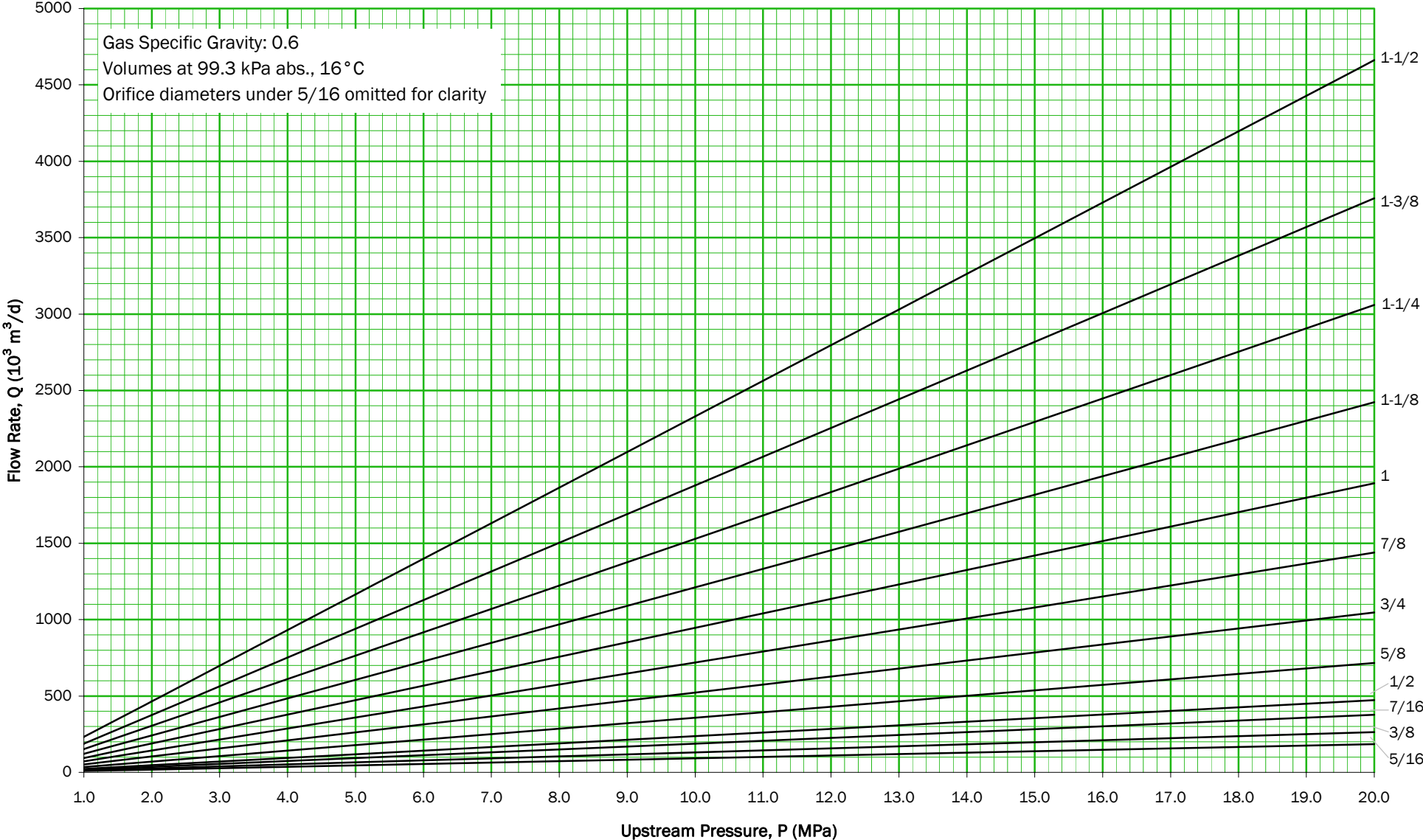
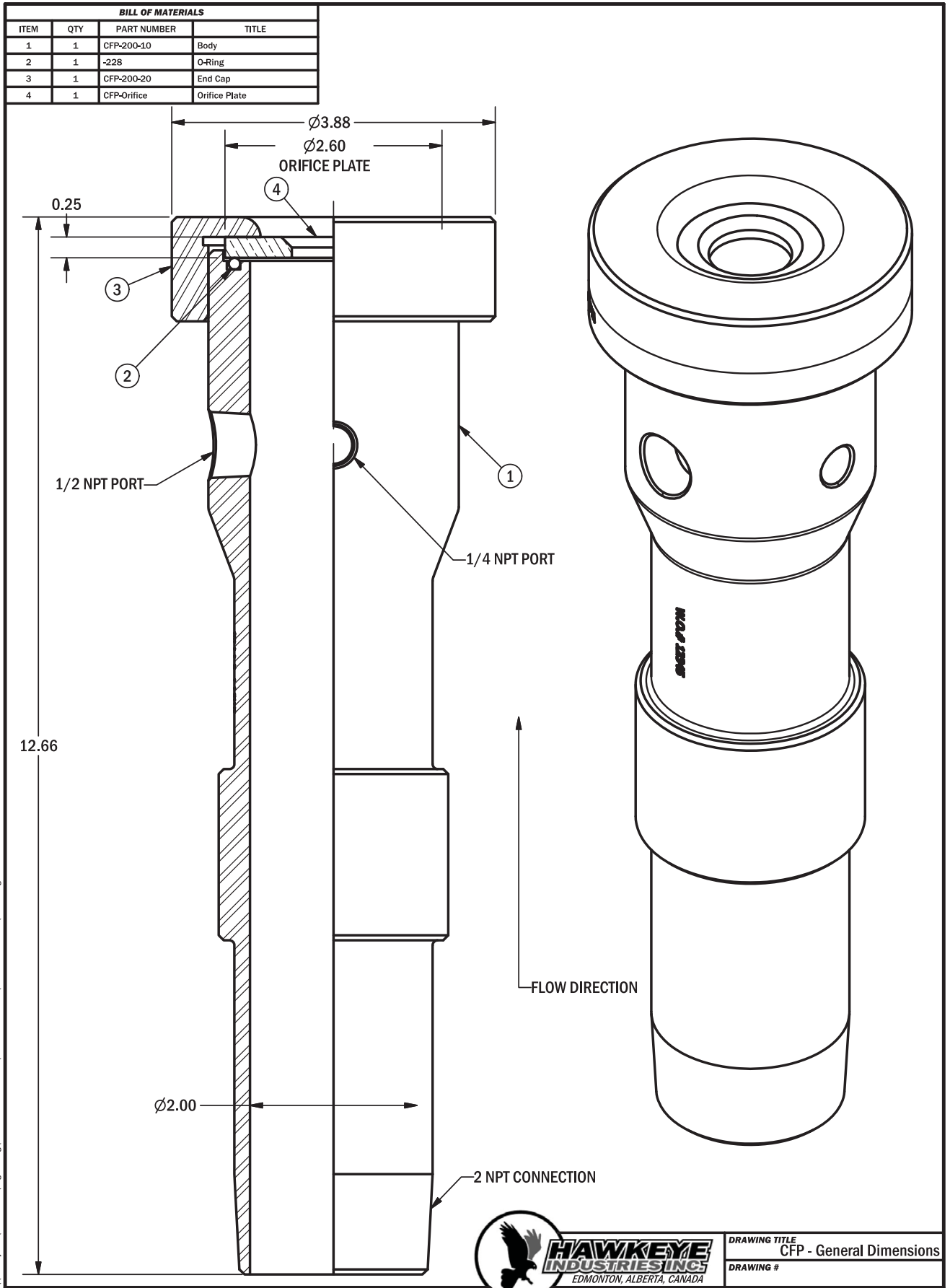

Chart D4: Flow Rate vs. Upstream Pressure (Metric Units)
20 MPa Upstream Pressure, Orifices 5/16 and over



Informational purposes only. Calculate flow rates using equation 1.

Revised August 2010



\\hawkeye-dc\SharedFiles\Engineering\Manufactured Products\Critical Flow Probes\Critical Flow Probes\CFP-200-gd2.dwg



DRAWING TITLE
CFP - General Dimensions
DRAWING #